

Assessing optimal dispatch and pool market (symmetric and asymmetric) results for different periods

Henrique Evora

Faculdade de Engenharia, Universidade do Porto, Rua Dr. Roberto Frias, 4200-465 PORTO, Portugal; Universidade Técnica do Atlântico, Mindelo, S. Vicente, Cabo Verde. (hrevora@uta.cv) ORCID [0000-0002-8764-4102](https://orcid.org/0000-0002-8764-4102)

Author Keywords

Optimal dispatch, Pool market, Power flow.

Type: Research Article

 Open Access

 Peer Reviewed

 CC BY

Abstract

This article presents a solution for a work related to the curricular unit Energy Markets and Regulation within the scope of PDEEC - Doctoral Program in Electrical and Computer Engineering. The task consists of evaluating optimal dispatch and market pool results (symmetric and asymmetric) for different periods. To check the technical feasibility of implementing the dispatch recommended by the pool market, a DC power flow is analyzed, by accounting for a network with six busbars. Results show that in some periods of higher demand, there could be an overload in some transmission lines of the considered network for certain results of market dispatch.

1. Introduction

Nowadays the evaluation of ideal dispatch and market pool results (symmetric and asymmetric) assumes extreme importance in electrical power systems and energy management. The assessment allows to optimization of the functioning of the electrical system, ensuring efficiency, reliability, and adequate costs.

EPRI (Electric Power Research Institute) and DOE (U.S. Department of Energy) handbook enlists several services various storage technologies may offer towards the transmission and distribution needs of the grid, their economic values, and possible monetization schemes (Eckroad and Gyuk 2003). Therefore, there have been many studies that investigate the process of optimally allocating energy storage in the grid for achieving goals related with either transmission or distribution systems. For instance, Yu et al. (2013) developed an optimal energy storage allocation method for DISCO (distribution companies) cost effective energy procurement under scenarios of high renewable penetration and price volatility. Battery energy storage was used as the representative storage for this purpose, and the allocation model, a nonlinear optimization problem, that provides the siting, sizing and operating strategy of the battery storage was solved based on fuzzy particle swarm optimization. A similar work was earlier done by Du Yun-feng (2011) for distribution system planning with the help of optimal allocation of energy storage in order to mitigate fluctuations caused by load and wind variability. In addition to the siting and sizing decisions, the cost-effective storage type was also identified.

The approach presented in this paper is based on a transmission network that includes the components presented in Figure 1. The network can be described as having six busbars, in which six generators and multiple loads are distributed through the different nodes according to the load distribution presented.

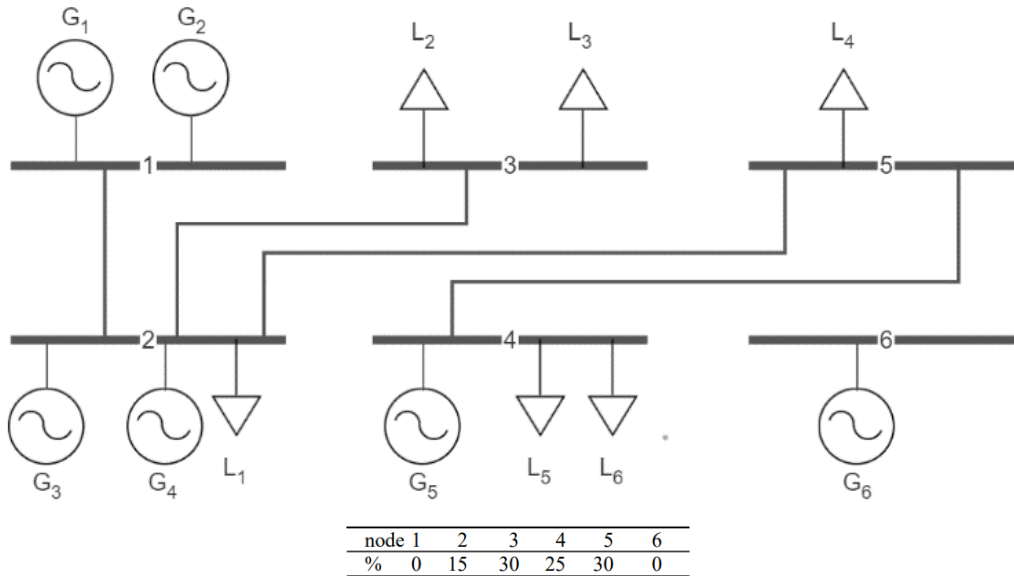

Figure 1: Basic network description and load distribution.

The main details of the transmission lines of the network are available in Table 1, in which all parameters considered are already calculated for the number of kilometers of each line. The power limit (of active power, in MW) was calculated from the nominal voltage (220 kV) and maximum current (160 A) through the expression:

$$P_{limit} = \sqrt{3} \cdot V_n \cdot I_{max} \cdot \cos(\varphi) = 45,7 \text{ MW}.$$

In this expression:

- P_{limit} limits for active generated power (MW)
- V_n nominal Voltage
- I_{max} maximum current

From-To	R (p.u.)	X (p.u.)	B (p.u.)	Limit (MW)
1-2	0,02	0,06	0,0006	45,7
1-3	0,08	0,24	0,0024	45,7
2-3	0,06	0,18	0,0018	45,7
2-4	0,06	0,18	0,0018	45,7
2-5	0,04	0,12	0,0012	45,7
3-4	0,01	0,03	0,0003	45,7
4-5	0,08	0,24	0,0024	45,7
5-6	0,01	0,03	0,0003	45,7

Table 1: Transmission Line Characteristics

Where:

- R (p.u.) resistance of Transmission Line in p.u.
- X (p.u.) reactance of Transmission Line in p.u.
- B (p.u.) susceptance of Transmission Line in p.u.

The main details and characteristics of the groups of generators contained in the network are presented in Table 2, with a and b being related to their cost functions.

Node	Nr Groups	Power	a	b
1	2	60	0.15	0.002
2	1	20	0.25	0.001
2	1	80	0.1	0.003
5	1	10	0.05	0.002
6	1	10	0.05	0.002

Table 2: Main Characteristics of Generator Groups

For the market pool operation, a set of buying and selling bids from different agents distributed through the network is provided. The bids are represented for different periods (1, 2, and 3) with the quantity (MW) and price (€/MWh) and can be consulted in Table 3 and 4.

Buying Bids								
Period 1			Period 2			Period 3		
node	quantity (MW)	price (€/MWh)	node	quantity (MW)	price (€/MWh)	node	quantity (MW)	price (€/MWh)
2	19,5	25	2	22,5	40	2	27,0	40
3	20,0	30	3	25,0	42	3	30,0	45
3	19,0	45	3	20,0	55	3	24,0	58
4	32,5	40	4	37,5	50	4	45,0	55
5	20,0	35	5	25,0	45	5	30,0	48
5	19,0	20	5	20,0	35	5	24,0	35

Table 3: Buying Bids for The Three Periods

Selling Bids								
Period 1			Period 2			Period 3		
node	quantity (MW)	price (€/MWh)	node	quantity (MW)	price (€/MWh)	node	quantity (MW)	price (€/MWh)
1	30	27	1	60	39	1	60	39
1	30	27	1	40	31	1	50	35
2	20	29	2	20	29	2	20	29
2	40	39	2	60	46	2	80	58
5	10	9	5	10	9	5	10	9
6	10	9	6	10	9	6	10	9

Table 4: Selling Bids for The Three Periods

2. Materials and Methods

This section deals with the solution of the four different Questions proposed in the assignment.

2.1. Question 2. a)

This question consists of solving an optimal dispatch without considering the proposed transmission network. This can be done by resorting to the cost functions of the different generators CF_g , which can be represented generically as:

$$CF_g = a_g \cdot P_g^{disp} + b_g \cdot (P_g^{disp})^2, \forall g \in G \tag{1}$$

The values (constants) for a and b can be consulted in Table 2. The objective is to perform the dispatch of each generator by minimizing the total cost associated with each period (Equation

2), which in turn depends on the power allocated to each generator. Therefore, Excel Solver¹ was utilized to minimize a cell that represented the total cost, with the *GRG Nonlinear* solver. The total cost is the sum of the costs of all generators (green cell in Table 5, 6 and 7), which accounts for the different cost functions, the power dispatched and the duration of the period. For the optimization, two constraints were considered for each period: i) the power dispatched by each generator must be in the interval between 0 and its maximum power P_g^{max} (Equation 3), ii) the sum of dispatched power from all generators must match the demand (Equation 4).

$$\min \sum_{g=1}^G Cost_g \tag{2}$$

subjected to:

$$0 \leq P_g^{disp} \leq P_g^{max}, \forall g \in G \tag{3}$$

$$\sum_{g=1}^G P_g^{disp} = D \tag{4}$$

Results from the optimization are described in Table 5, 6, and 7 for each period (1, 2, and 3), respectively.

Generator	Node	P (MW)	Period 1		
			Dispatch (MW)	Price (\$/MWh)	Cost (\$)
G_1	1	60	32,5	0,215	104,81
G_2	1	60	32,5	0,215	104,81
G_3	2	20	15	0,265	59,62
G_4	2	80	30	0,190	85,50
G_5	5	10	10	0,070	10,50
G_6	6	10	10	0,070	10,50
Total		240	130	1,025	375,75

Table 5: Optimal dispatch for period 1

Generator	Node	P (MW)	Period 2		
			Dispatch (MW)	Price (\$/MWh)	Cost (\$)
G_1	1	60	38,125	0,226	25,88
G_2	1	60	38,125	0,226	25,88
G_3	2	20	20	0,270	16,20
G_4	2	80	33,75	0,201	20,38
G_5	5	10	10	0,070	2,10
G_6	6	10	10	0,070	2,10
Total		240	150	1,063	92,53

Table 6: Optimal dispatch for period 2

¹ Excel Solver is an optimization tool available in Microsoft Excel. It is an add-in that helps users find the optimal solution to a problem by adjusting the values in a set of cells, subject to certain constraints.

Generator	Node	P (MW)	Period 3		
			Dispatch (MW)	Price (\$/MWh)	Cost (\$)
G_1	1	60	49,375	0,249	73,69
G_2	1	60	49,375	0,249	73,69
G_3	2	20	20	0,270	32,40
G_4	2	80	41,25	0,224	55,39
G_5	5	10	10	0,070	4,20
G_6	6	10	10	0,070	4,20
Total		240	180	1,132	243,56

Table 7: Optimal dispatch for period 3

For Period 1, generators G_5 and G_6 are generating at the maximum capacity (10 MW), while the remaining G_1 , G_2 , G_3 , and G_4 are generating, respectively, 32.5, 32.5, 15, and 30 MW. For Period 2, generators G_3 , G_5 and G_6 are generating at the maximum capacity (20, 10, and 10 MW, respectively), while the remaining G_1 , G_2 , and G_4 are generating, respectively, 38.125, 38.125, and 33.75 MW. For Period 3, generators G_3 , G_5 and G_6 are generating at the maximum capacity (20, 10, and 10 MW, respectively), while the remaining G_1 , G_2 , and G_4 are generating, respectively, 49.375, 49.375, and 41.25 MW.

The system overall goes from working at 54% to 75% capacity from Period 1 to Period 3 due to the increased demand (130 to 180 MW). The calculation of the generational marginal cost (MC) is given, for each Period, by the derivative of the total cost function (J. T. Saraiva 2018) and is represented in Equation 5. The value for the system can be represented by the maximum marginal cost presented for all dispatched generators.

$$MC_g = a + 2 \cdot b \cdot P_g^{disp}, \forall g \in G \tag{5}$$

In this expression:

- MC_g Generation marginal cost
- a, b Constant in Table 2
- P_g^{disp} power allocated to each generator.

Marginal costs are depicted in Table 8. As the load increases (from Period 1 to Period 3) the marginal cost also increases, which is a consequence of the dependency that cost has on the power generated.

Period	Marginal Cost (\$/MWh)
1	0.28
2	0.30
3	0.35

Table 8: The marginal cost for different periods

2.2. Question 2. b)

In this question, a set of buying and selling bids for the three periods is proposed. It is assumed that the market is symmetric and voluntary, which means that both buying and selling bids are considered (J. T. Saraiva 2018). These buying and selling bids are presented in Table 3 and 4. As seen in Figure 2, 3, and 4, the market-clearing pair of quantity and price can be

immediately computed by intersecting the buying and selling curves, after ordering the bids in descending and ascending order, respectively.

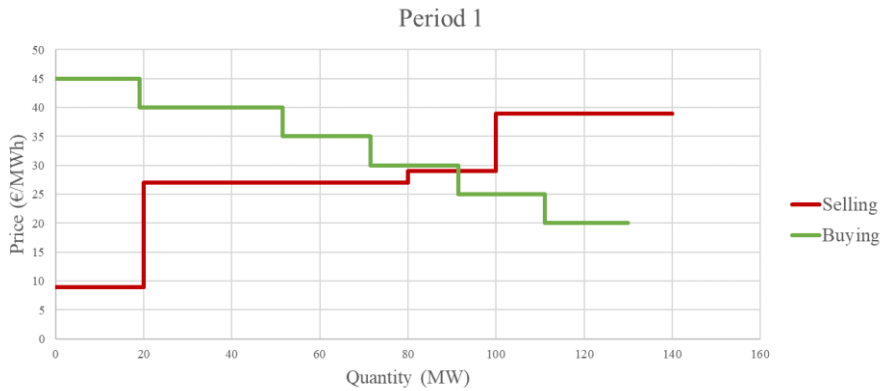

Figure 2: Aggregated curves for Period 1.

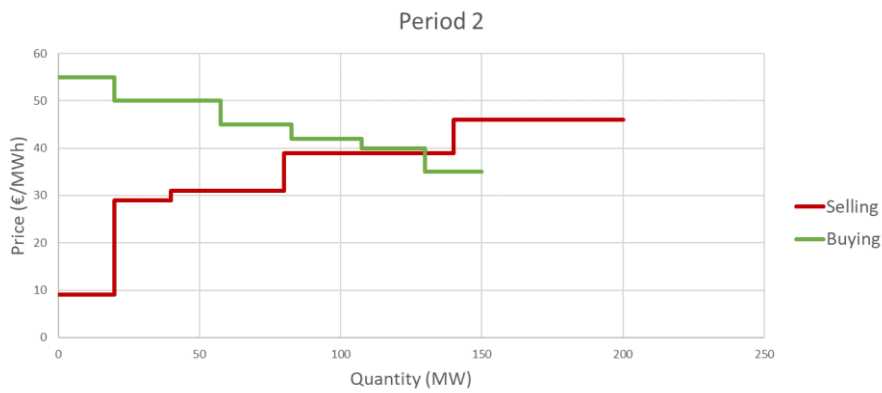

Figure 3: Aggregated curves for Period 2.

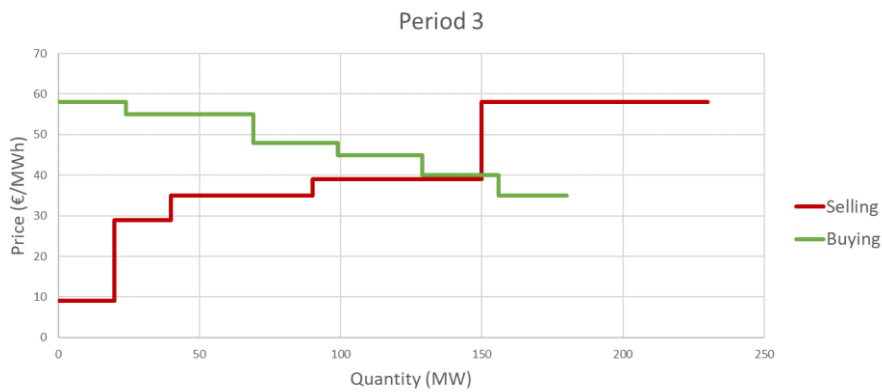

Figure 4: Aggregated curves for Period 3.

The results for the market clearing (price, quantity) were: (29 €/MWh, 91.5 MW) for Period 1, (39 €/MWh, 130 MW) for Period 2, and (39 €/MWh, 150 MW) for Period 3. The marginal is the price offered by the last unit to be dispatched (J. T. Saraiva 2018), thus is 29, 39, and 39 €/MWh. However, the market price and quantity can also be computed by solving an optimization problem related to the mathematical formulation of a symmetric pool market, which aims to maximize social welfare. This concept of social welfare relates to the area in the plot between the aggregated curves, until the intersection point. The optimization problem can be formulated in the following way (J. T. Saraiva 2018):

$$\max \left(\sum_{i=1}^{N_D} C_{D_i}^{bid} \cdot P_{D_i} - \sum_{j=1}^{N_G} C_{G_j}^{bid} \cdot P_{G_j} \right) \tag{6}$$

subjected to:

$$0 \leq P_{D_i} \leq P_{D_i}^{bid} \tag{7}$$

$$0 \leq P_{G_i} \leq P_{G_i}^{bid} \tag{8}$$

$$\sum_{i=1}^{N_G} P_{G_j} = \sum_{i=1}^{N_D} P_{D_i} \tag{9}$$

Results from the optimization are made available in Table 9, 10, and 11 for Periods 1, 2, and 3, respectively. Social Welfare was valued at 1321.5€, 2100€, and 2647€ for the consecutive periods. Now that the market was cleared, one can use the market clearing price to compute the amount of money that market agents must pay and receive, by summing the three periods to get the daily amount. Per period, the amount is calculated by multiplying the quantity and market price obtained by the optimization, and by the number of hours that the period represents. The summary of the total amount of money to receive and pay is presented in Table XII. In Period 1, selling bids for Node 2 were partially met or even not met, while both buying bids from Nodes 2 and 5 were not met. In Period 2, one of the selling bids from Node 1 was partially met, and one for Node 2 was not met, while for buying, Node 5 did not enter the market. In Period 3, the largest bid from Node 2 was eliminated, while for buying bids, Node 2 had the bid partially met and Node 5 had its lowest bid eliminated from the market.

Period 1					
Selling			Buying		
Node	P_G^{bid} (MW)	P_G (MW)	Node	P_D^{bid} (MW)	P_D (MW)
5	10	10	3	19	19
6	10	10	4	32,5	32,5
1	30	30	5	20	20
1	30	30	3	20	20
2	20	11,5	2	19,5	0
2	40	0	5	19	0

Table 9: Dispatch for Period 1

Period 2					
Selling			Buying		
Node	P_G^{bid} (MW)	P_G (MW)	Node	P_D^{bid} (MW)	P_D (MW)
5	10	10	3	20	20
6	10	10	4	37,5	37,5
2	20	20	5	25	25
1	40	40	3	25	25
1	60	50	2	22,5	22,5
2	60	0	5	20	0

Table 10: Dispatch for Period 2

Period 3					
Selling			Buying		
Node	P_G^{bid} (MW)	P_G (MW)	Node	P_D^{bid} (MW)	P_D (MW)
5	10	10	3	24	24
6	10	10	4	45	45
2	20	20	5	30	30
1	50	50	3	30	30
1	60	60	2	27	21
2	80	0	5	24	0

Table 11: Dispatch for Period 3

Sum of Periods			
Selling		Buying	
Node	To Receive (€)	Node	To Pay (€)
1	62 370,00 €	2	7 546,50 €
2	12 022,50 €	3	34 866,00 €
5	7 860,00 €	4	29 055,00 €
6	7 860,00 €	5	18 645,00 €
Total	90 112,50 €	Total	90 112,50 €

Table 12: Total Amount for Agents to Pay and Receive

2.3. Question 2. c)

In this question, it is assumed that the market is asymmetric and mandatory, thus only the generation (buying) bids are contemplated (J. T. Saraiva 2018) for the market clearing operation. For the asymmetric pool market, we have the following optimization for the problem:

$$\max \left(- \sum_{j=1}^{N_G} C_{G_j}^{bid} \cdot P_{G_j} \right) \quad (10)$$

subjected to:

$$0 \leq P_{G_i} \leq P_{G_i}^{bid} \quad (11)$$

$$\sum_{j=1}^{N_G} P_{G_j} = \sum_{i=1}^{N_D} P_{D_i}^{spec} \quad (12)$$

In this expression:

- $C_{G_j}^{bid}$ bid cost of each generator
- P_{G_j} power generated by each generator
- $P_{D_i}^{spec}$ specified power demand
- N_G total number of generators
- N_D total number of Demands

The results for the market clearing (price, quantity) were: (39 €/MWh, 130 MW) for Period 1, (46 €/MWh, 150 MW) for Period 2, and (58 €/MWh, 180 MW) for Period 3, as seen in Figure 5, 6, and 7, respectively by intersecting the selling curve with a vertical line that represents the inelastic demand. The same result can be taken from the optimization problem with asymmetric formulation, for which the dispatch results are available in Table 13, 14, and 15, respectively.

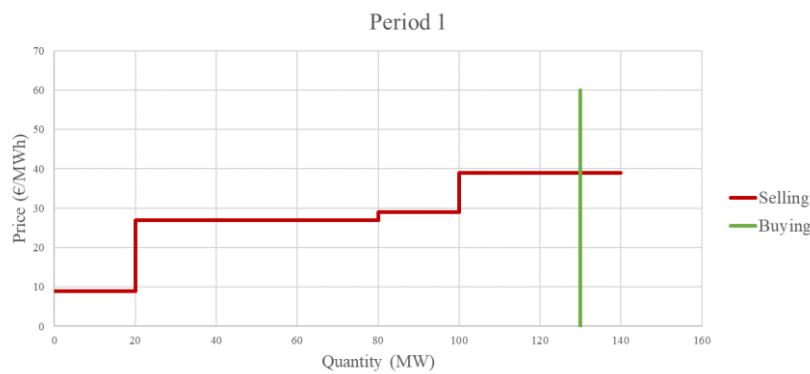

Figure 1: Market Clearing for Period 1 (asymmetric).

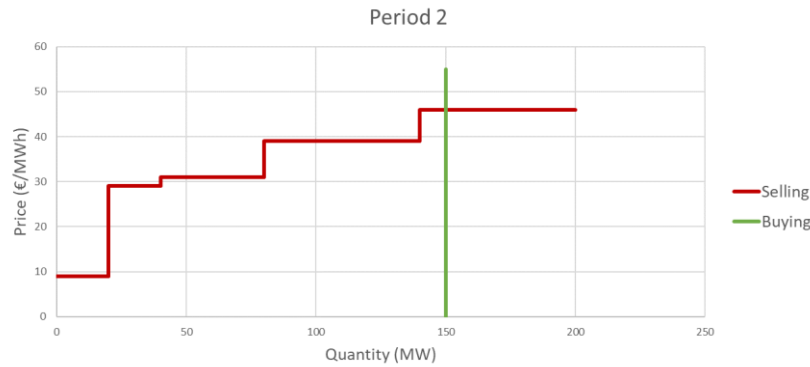

Figure 6: Basic Market Clearing for Period 2 (asymmetric).

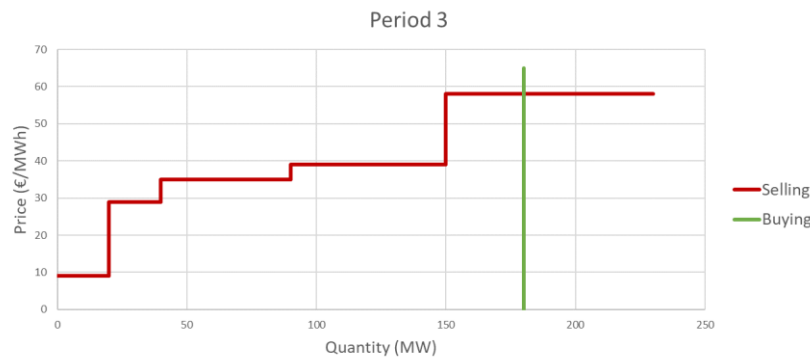

Figure 7: Basic Market Clearing for Period 3 (asymmetric).

Period 1		
Selling		
Node	P_G^{bid} (MW)	P_G (MW)
5	10	10
6	10	10
1	30	30
1	30	30
2	20	20
2	40	30

Table 13: Dispatch for Period 1 (asymmetric)

Period 2		
Selling		
Node	P_G^{bid} (MW)	P_G (MW)
5	10	10
6	10	10
1	20	20
1	40	40
2	60	60
2	60	10

Table 14: Dispatch for Period 2 (asymmetric)

Period 3		
Selling		
Node	P_G^{bid} (MW)	P_G (MW)
5	10	10
6	10	10
1	20	20
1	50	50
2	60	60
2	80	30

Table 15: Dispatch for Period 3 (asymmetric)

Finally, the amounts that the agents with selling bids must receive can be calculated in the same way of question 2b), by accounting for dispatched generation, the market clearing price, and each period duration, but with the load distribution assumed in Figure 1. The results are presented in Table 16.

Selling		Buying	
Node	To Receive (€)	Node	To Pay (€)
1	87 180,00	2	23 908,50
2	50 790,00	3	47 817,00
5	10 710,00	4	39 847,50
6	10 710,00	5	47 817,00
Total	159 390,00	Total	159 390,00

Table 16: The Total Amount for Agents to Receive

2.4. Question 2. d)

The main objective of this question is to evaluate the technical feasibility of the results obtained from the market clearing in question 2 b), using power flow analysis. This means that, unlike the previous questions, we must account for transmission network proposed. To run a DC Power Flow, the software Power World Simulator 22² was used. The network was drawn schematically and the values for generators, loads, and transmission lines were introduced. For each period, it is possible to retrieve the operating conditions of the lines. Table 17, 18 and 19 represent results for Period 1, 2, and 3, respectively, by indicating the power that flows through each branch of the network, while also representing in terms of percentage of the power limit established in Section I for all branches.

Period 1			
From-To	Power (MW)	MW Limit	% MW Limit
1-2	36,64	45,7	80,18
1-3	23,36	45,7	51,11
2-3	18,93	45,7	41,42
2-4	19,48	45,7	42,62
2-5	9,74	45,7	21,31
3-4	3,29	45,7	7,19
4-5	-9,74	45,7	21,31
5-6	-10	45,7	21,88

Table 17: DC power flow results for period 1

Period 2			
From-To	Power (MW)	MW Limit	% MW Limit
1-2	59,5	45,7	130,2
1-3	30,5	45,7	66,74
2-3	20,83	45,7	45,59
2-4	21,89	45,7	47,9
2-5	14,28	45,7	31,24
3-4	6,33	45,7	13,86
4-5	-9,28	45,7	20,3
5-6	-10	45,7	21,88

Table 18: DC power flow results for period 2

Period 3			
From-To	Power (MW)	MW Limit	% MW Limit
1-2	72,86	45,7	159,42
1-3	37,14	45,7	81,28
2-3	25,24	45,7	55,23
2-4	26,63	45,7	58,28
2-5	19,98	45,7	43,73
3-4	8,38	45,7	18,34
4-5	-9,98	45,7	21,85
5-6	-10	45,7	21,88

Table 19: Dc Power Flow Results for Period 3

² is an interactive power system simulation package (version 22) designed to simulate high voltage power system operation on a time frame ranging from several minutes to several days.

As can be seen from the previous tables, for Period 1 there seems to be no problem in terms of technical feasibility from the network perspective. For Period 2 and 3, results indicate a possible overload problem in branch 1-2, for which the power flowing through it is 1.30 and 1.59 times higher than the maximum value assumed, respectively.

Due to the possible technical problems found for the network, two possible solutions can be indicated: i) the network operator could reinforce the transmission lines, especially the connectivity between Bus 1 and the remaining buses; ii) the market operator could provide a new dispatch that accounts for the constraints found. As an example, one can try replacing the last bid that was cleared for Period 2 and 3 (which belong to Bus 1) with the next one, which belongs to Bus 2. By analyzing Figure 1, one can see that Bus 2 has a greater transmission capacity due to having more lines connected with other buses, thus could provide a technically feasible solution for the new market dispatch, although worsening social welfare. The results for this change in the market dispatch for Period 3 was implemented in the software, and the results for the DC Power Flow can be consulted in Table 20, which shows that no overload is now present in the network. The same assessment could be done for Period 2, which is less critical than Period 3.

From-To	Power (MW)	MW Limit	% MW Limit
1-2	22,29	45,7	48,78
1-3	27,71	45,7	60,63
2-3	29,52	45,7	64,60
2-4	30,06	45,7	65,78
2-5	21,7	45,7	47,48
3-4	3,24	45,7	7,09
4-5	-11,7	45,7	25,60
5-6	-10	45,7	21,88

Table 20: DC power flow results with possible changes in dispatch (period 3)

3. Discussion and Conclusions

At the end of each partial question a partial discussion of partial results was held. However, as an overall conclusion we can consider the following:

- When solving the optimal dispatch problem in the first question, it was found that the cost function's dependency on power led to an increase in marginal cost from Period 1 to 3, as the demand increased.
- When considering a pool market, for the same selling bids, the amount to be received by the selling agents increased from 90112,5€ to 159390,0€ when going from the symmetric to the asymmetric pool, which is due to the inelastic demand and lack of possibility to account for demand-side (buying) bids.
- For the DC Power Flow, by considering the network one can assess the technical feasibility of the results obtained from the economic dispatch. In this case, for Period 2 and 3 it was found that the network is overloaded in one of the lines (1-2).

In summary, the evaluation of ideal dispatch and market pool results is crucial for performance optimization of power systems and energy markets. It enables efficient resource allocation, cost reduction, and the integration of renewable energy sources, contributing to a more sustainable and resilient energy sector.

References

- Eckroad, Steven. 2003. "EPRI-DOE Handbook of Energy Storage for Transmission and Distribution Applications," January. <https://www.sandia.gov/ess-ssl/publications/ESHB%201001834%20reduced%20size.pdf>.
- Saraiva, J. T. 2018. "Electricity Markets: An Introduction". Faculty of Engineering of the University of Porto.
- Yun-feng, Du. 2011. "Optimal Allocation of Energy Storage System in Distribution Systems." *Procedia Engineering* 15:346–51. <https://doi.org/10.1016/j.proeng.2011.08.067>.
- Zheng, Yu, Zhao Yang Dong, Feng Ji Luo, Ke Meng, Jing Qiu, and Kit Po Wong. 2014. "Optimal Allocation of Energy Storage System for Risk Mitigation of DISCOs With High Renewable Penetrations." *IEEE Transactions on Power Systems* 29 (1): 212–20. <https://doi.org/10.1109/TPWRS.2013.2278850>.